

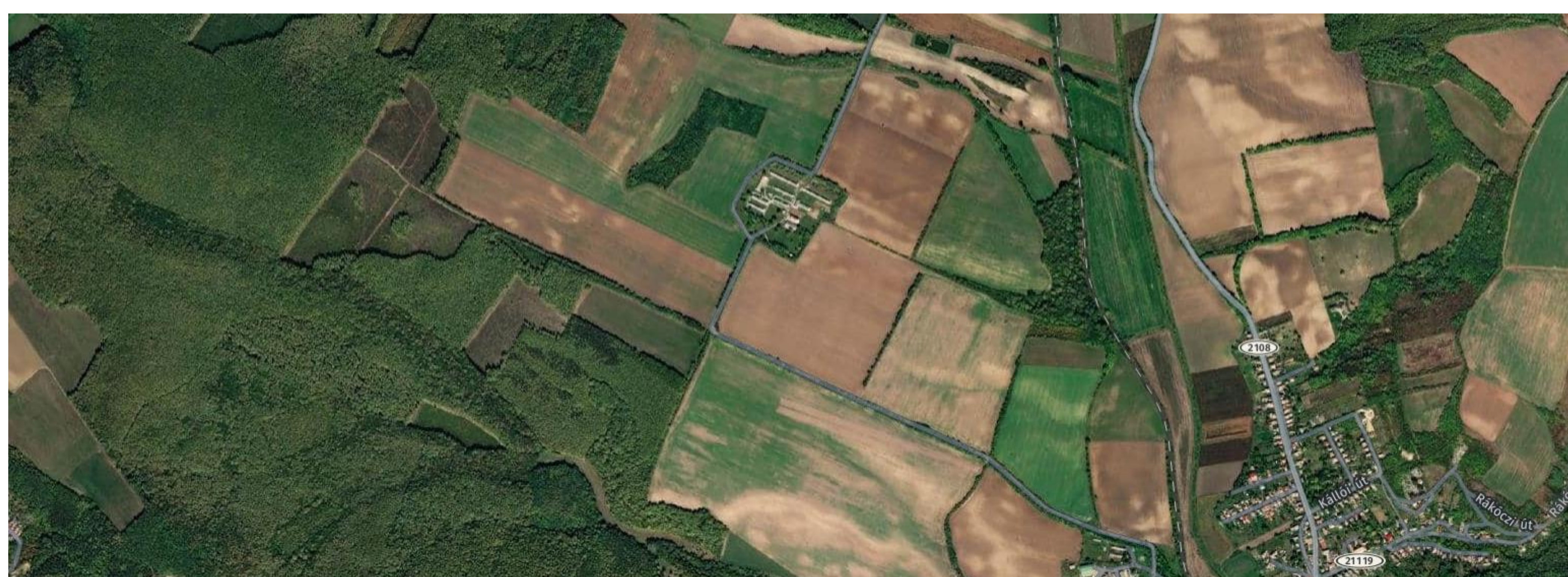

GALAMBOSPUSZTA/GALAMBOSMAJOR

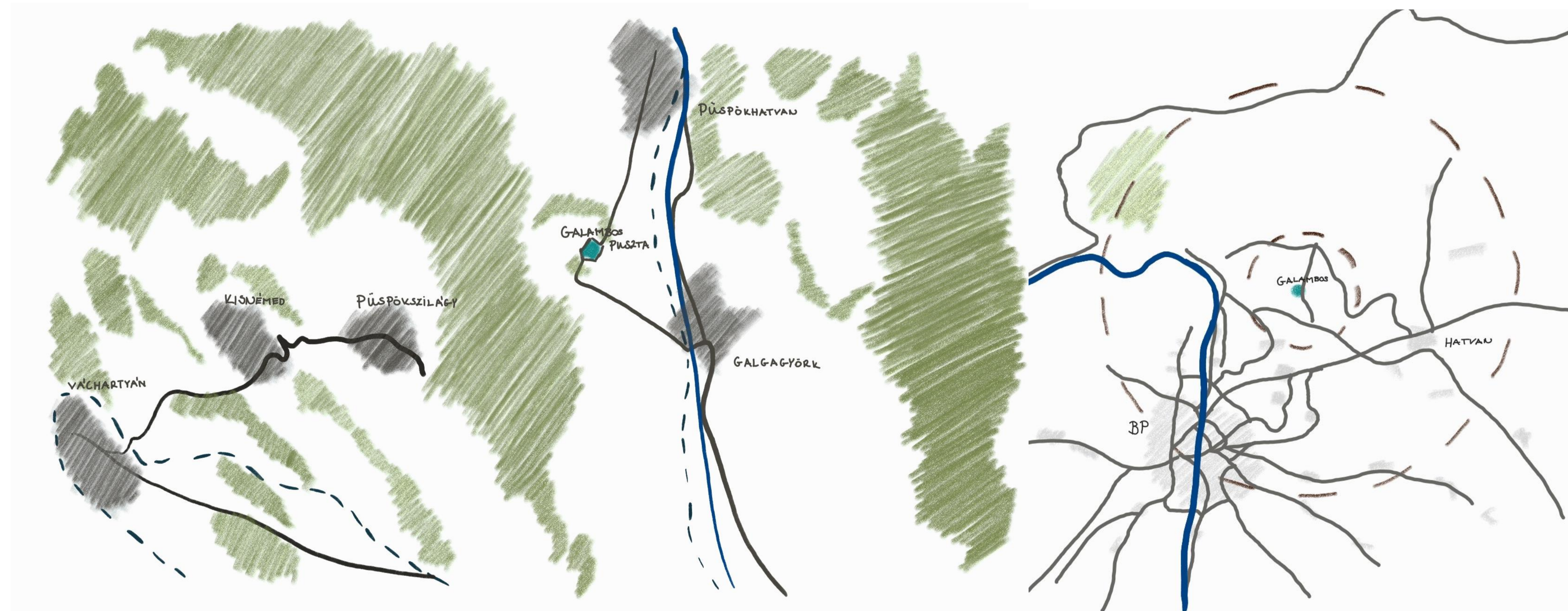

REGENERATÍV/LÁTVÁNYGAZDASÁG

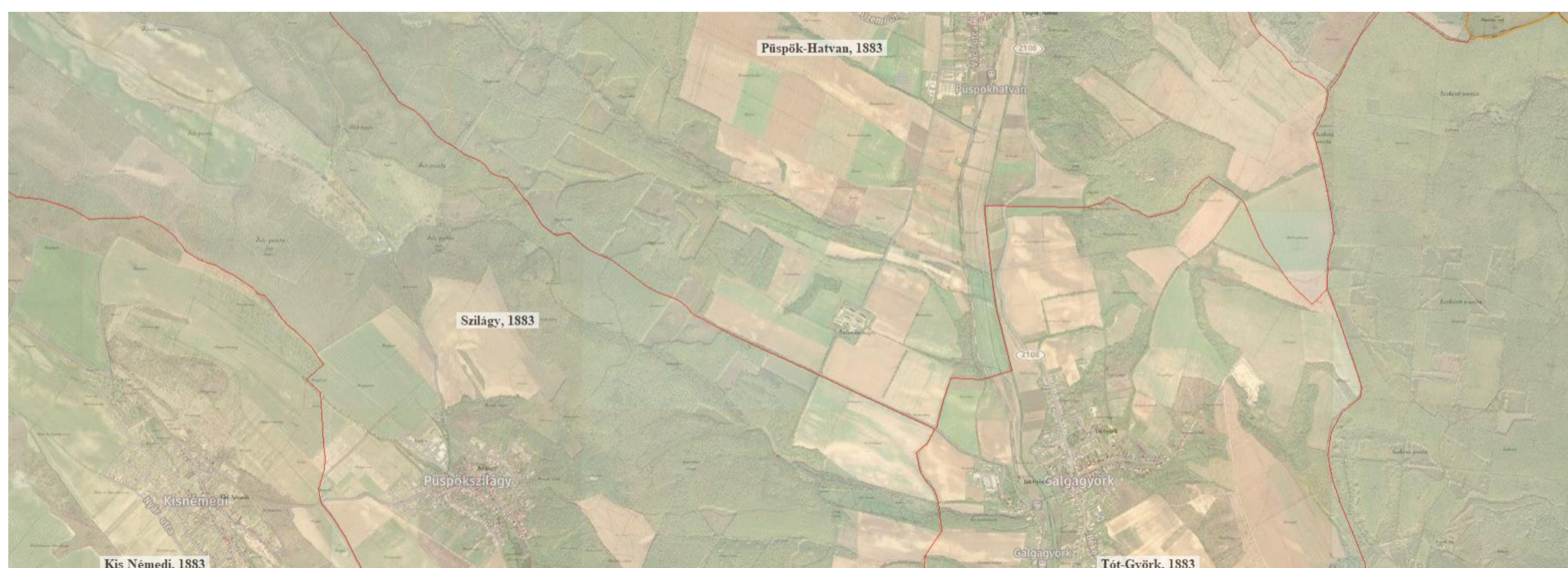
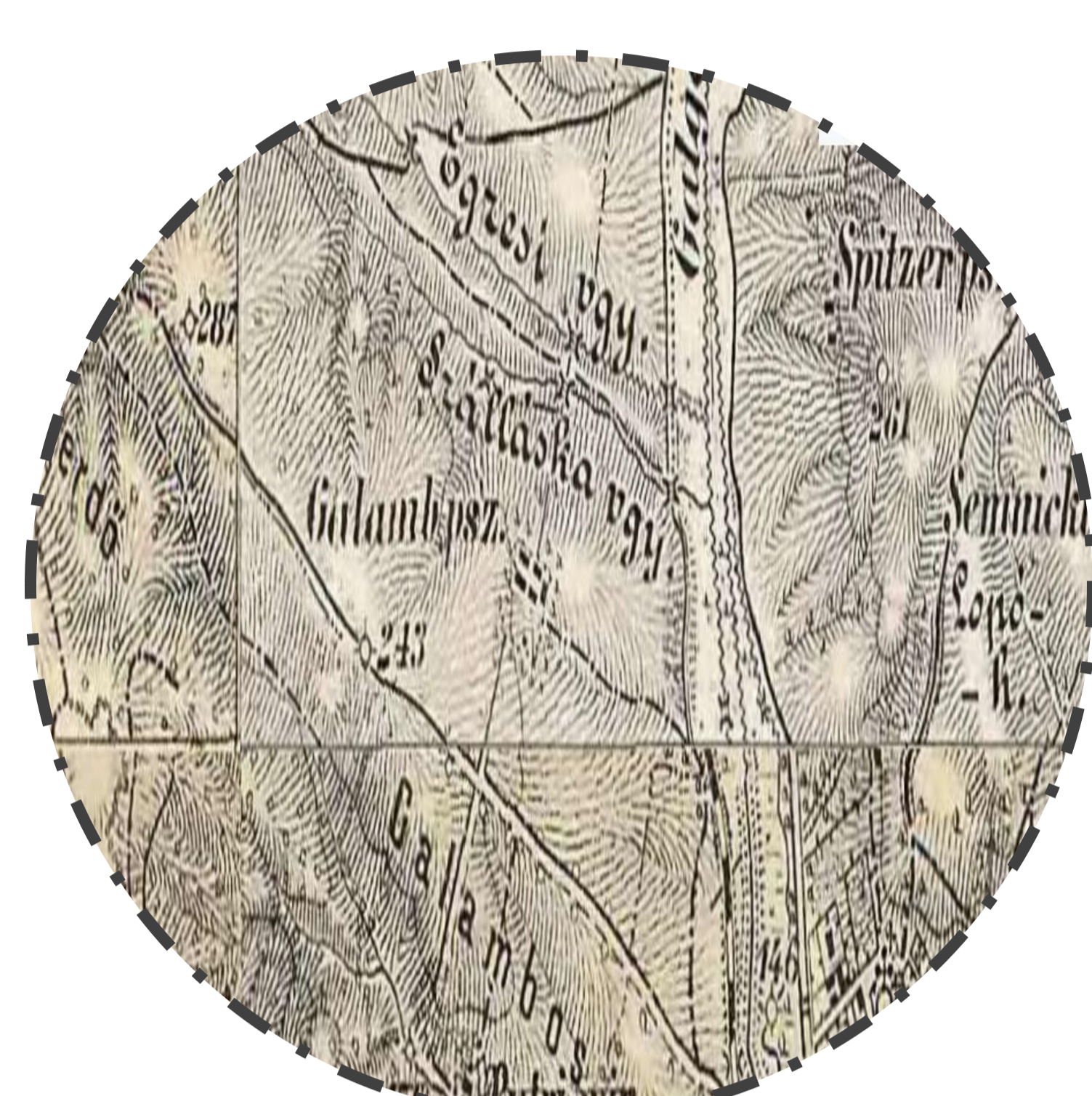
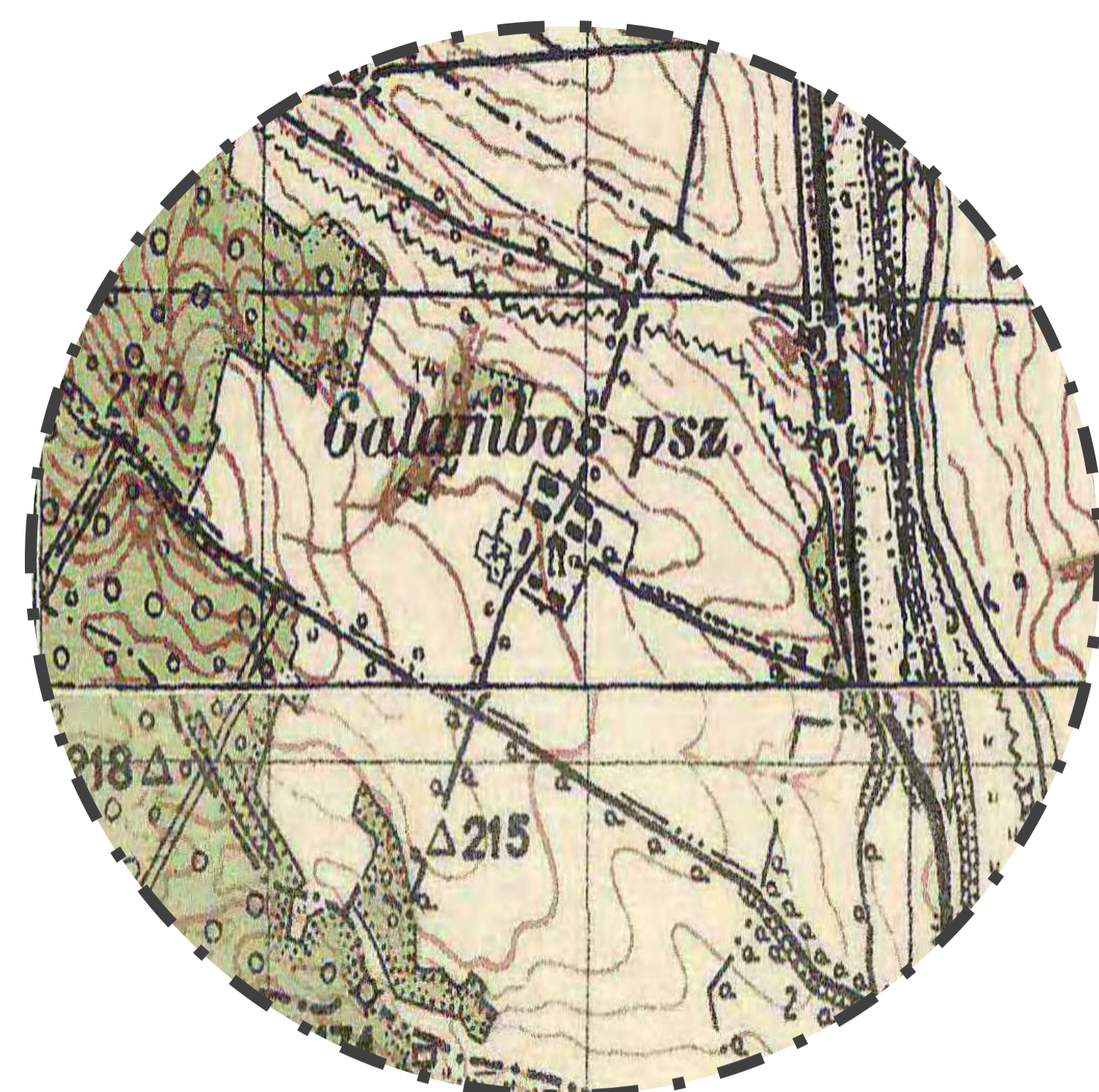
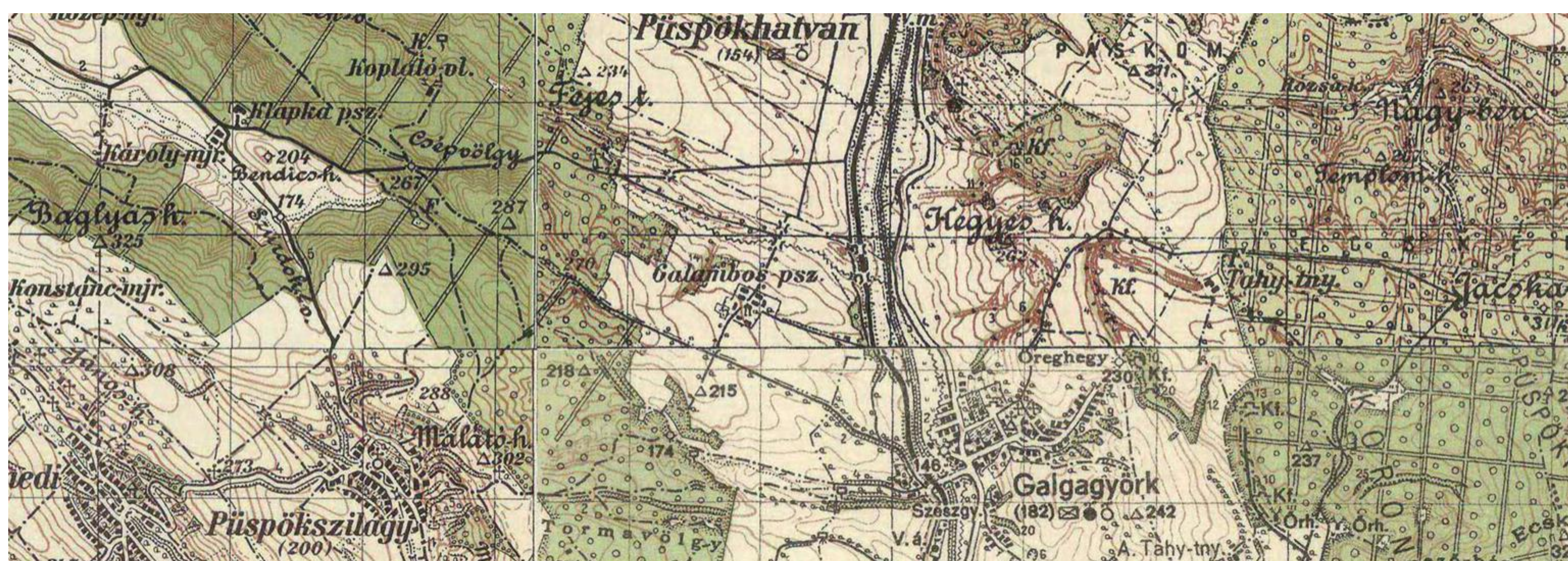
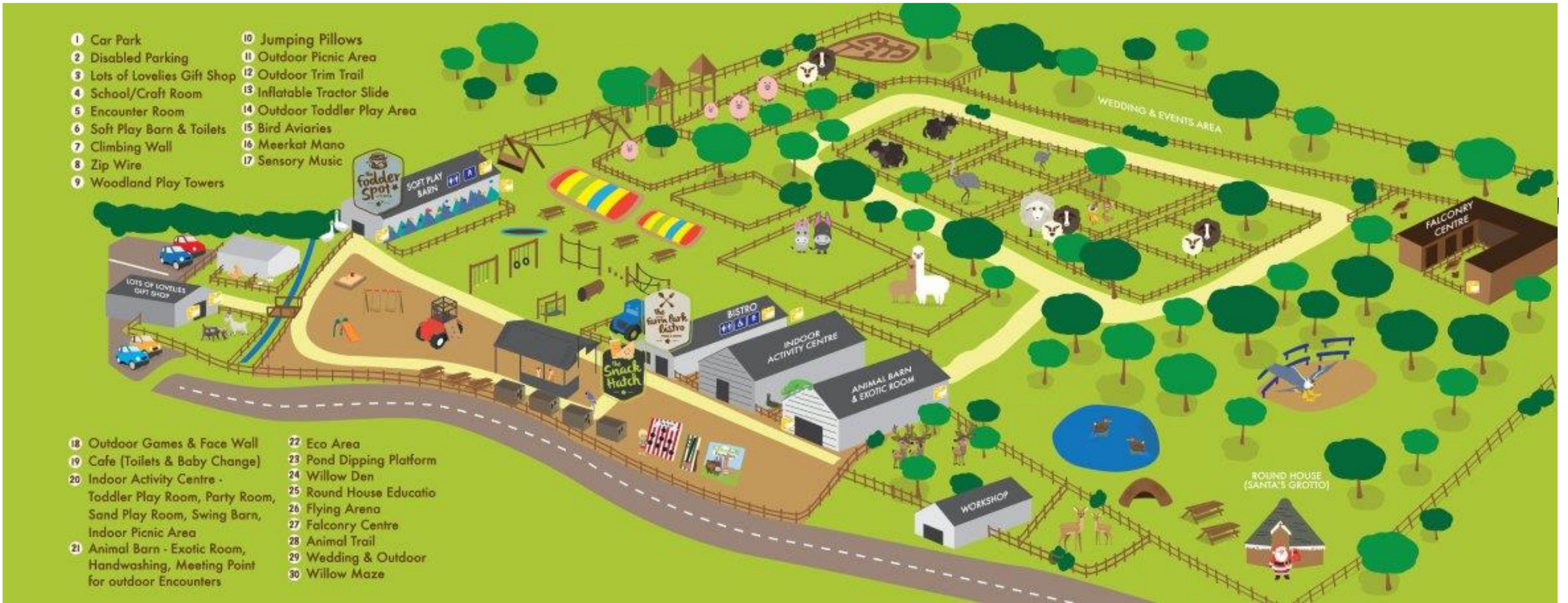

BERUHÁZÁSI KONCEPCIÓ - ÜTEMEZÉS

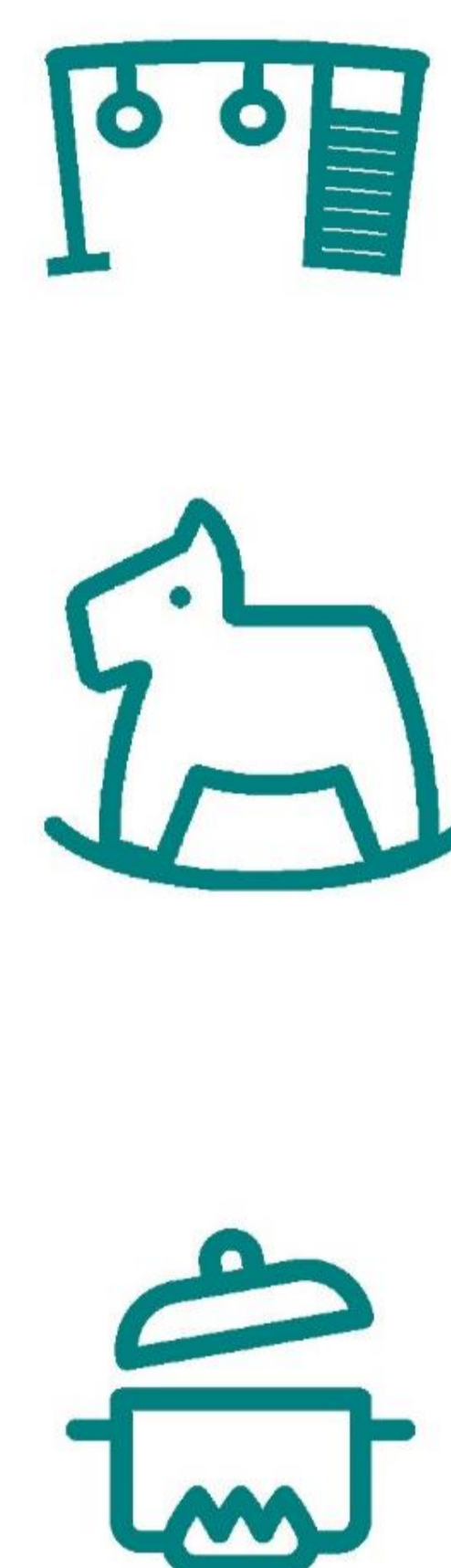
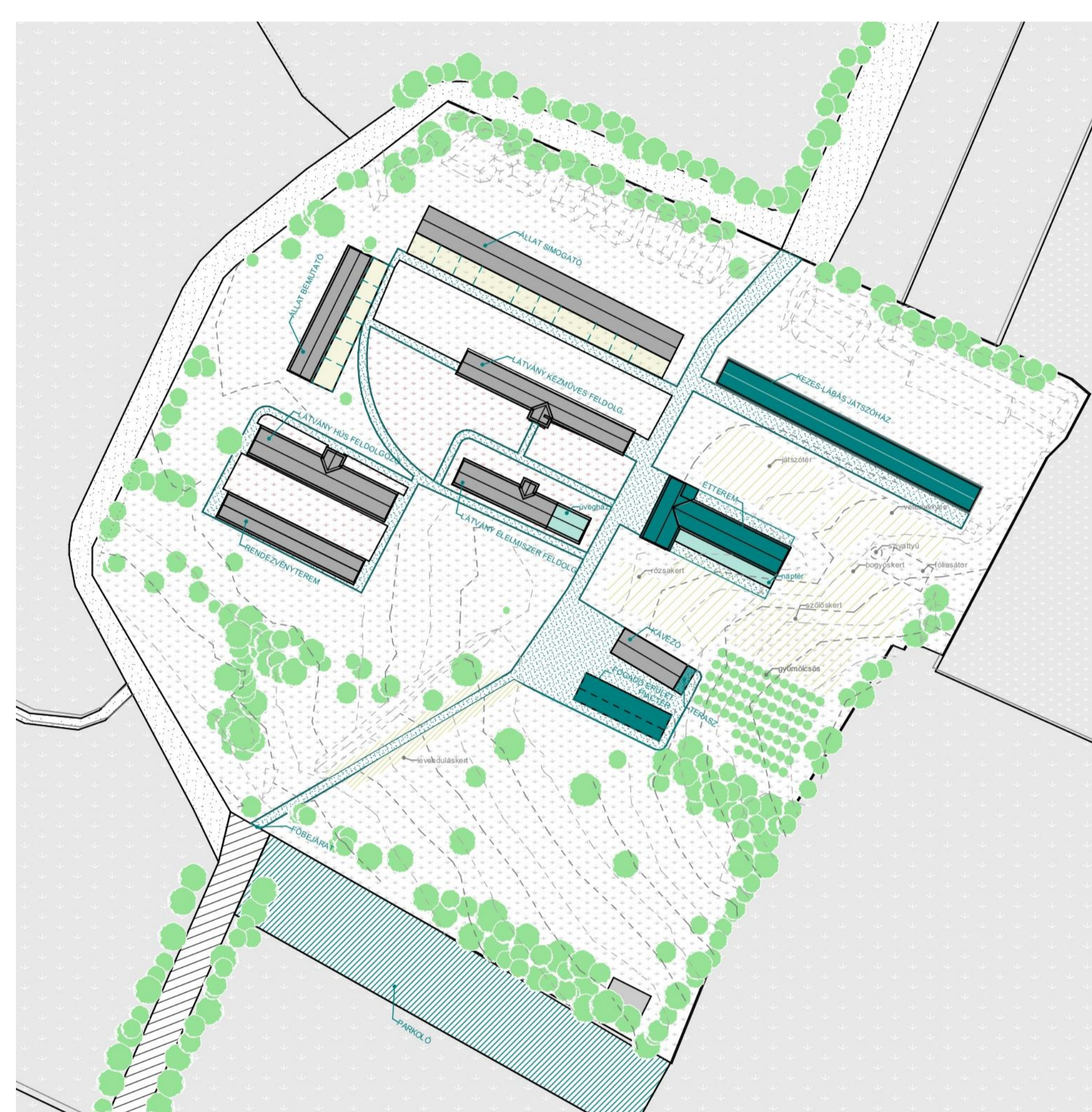
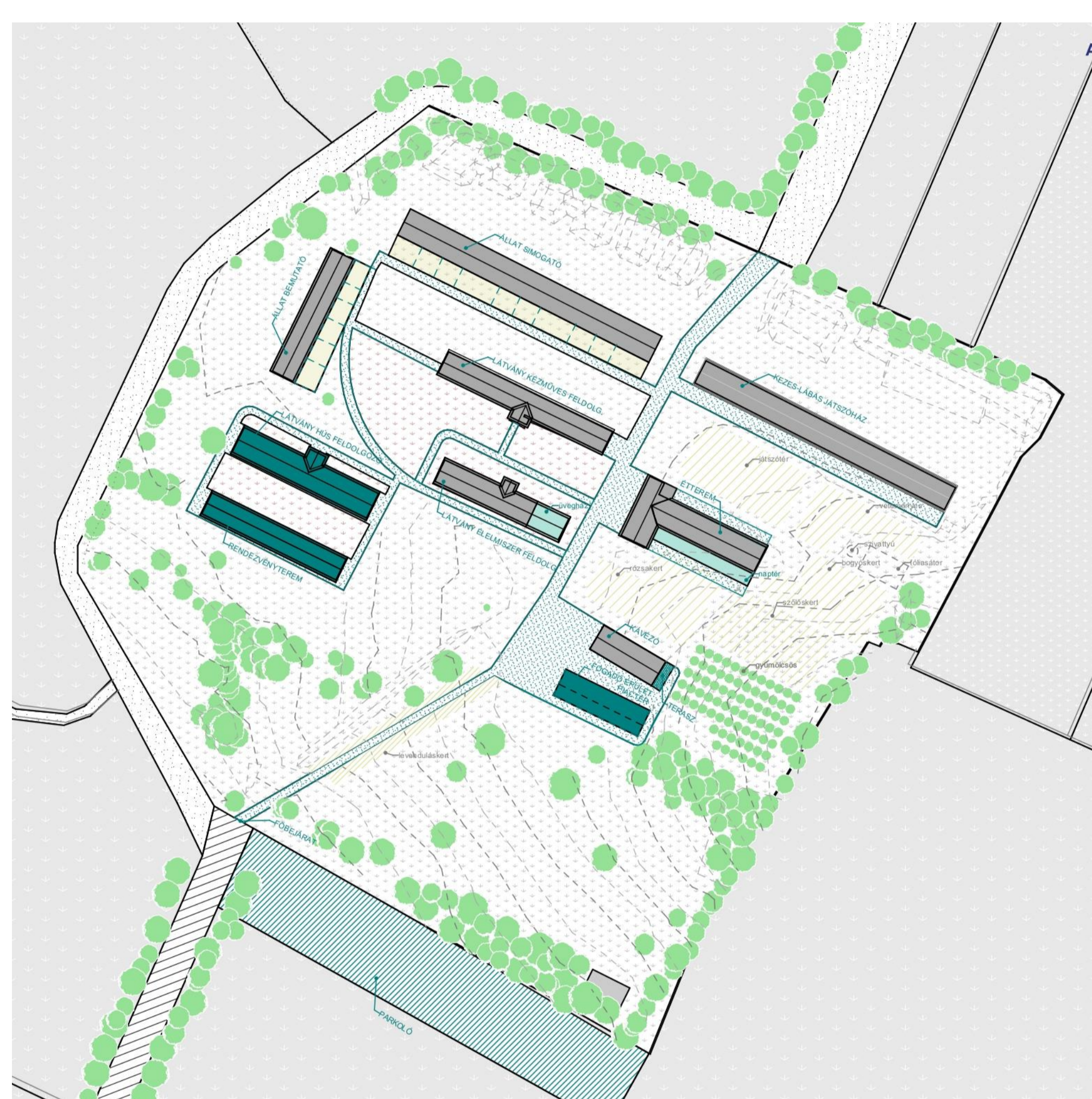
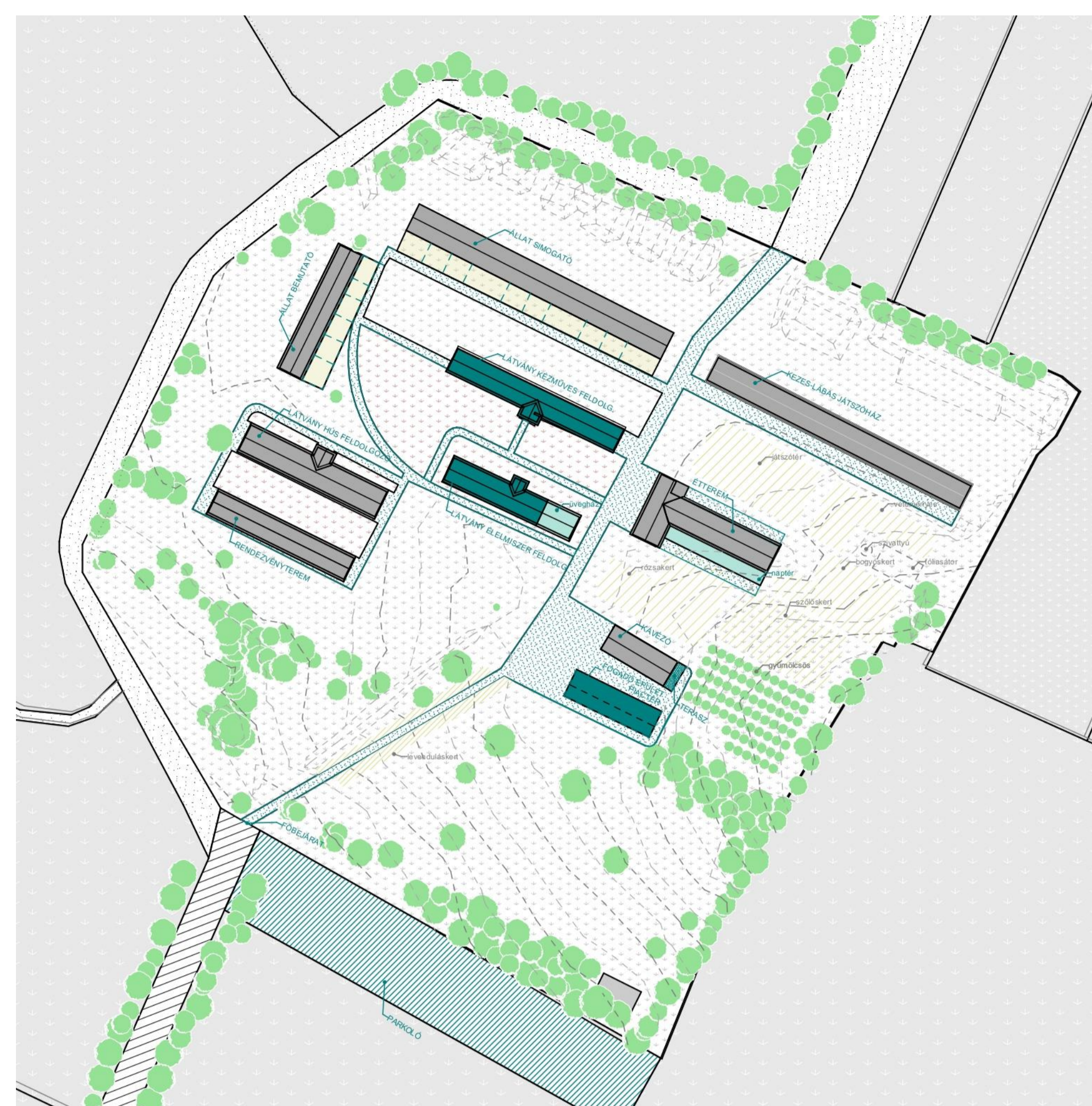
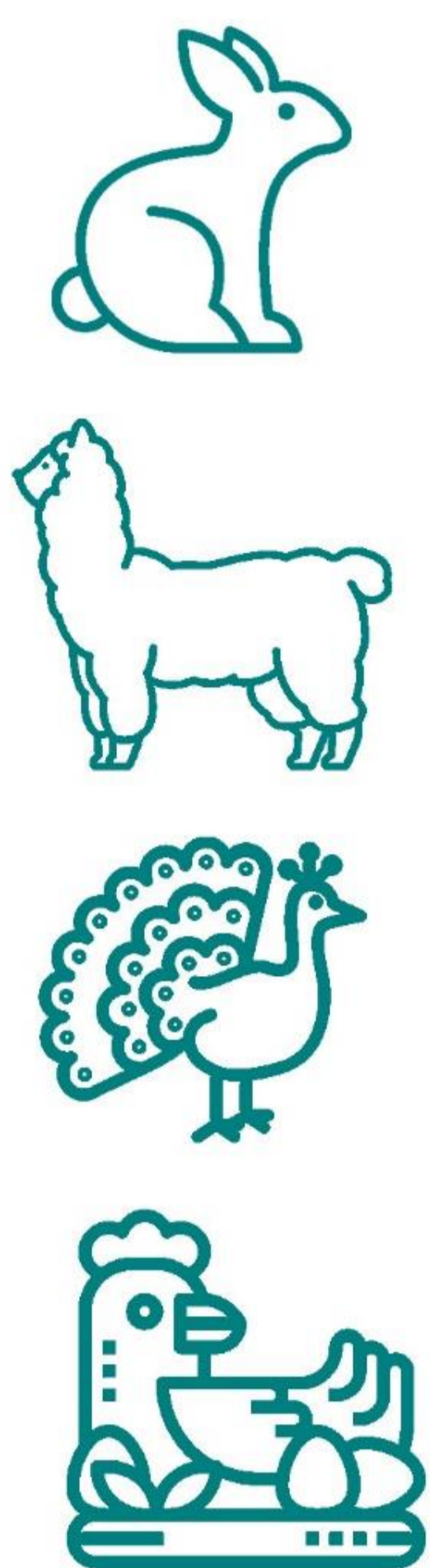
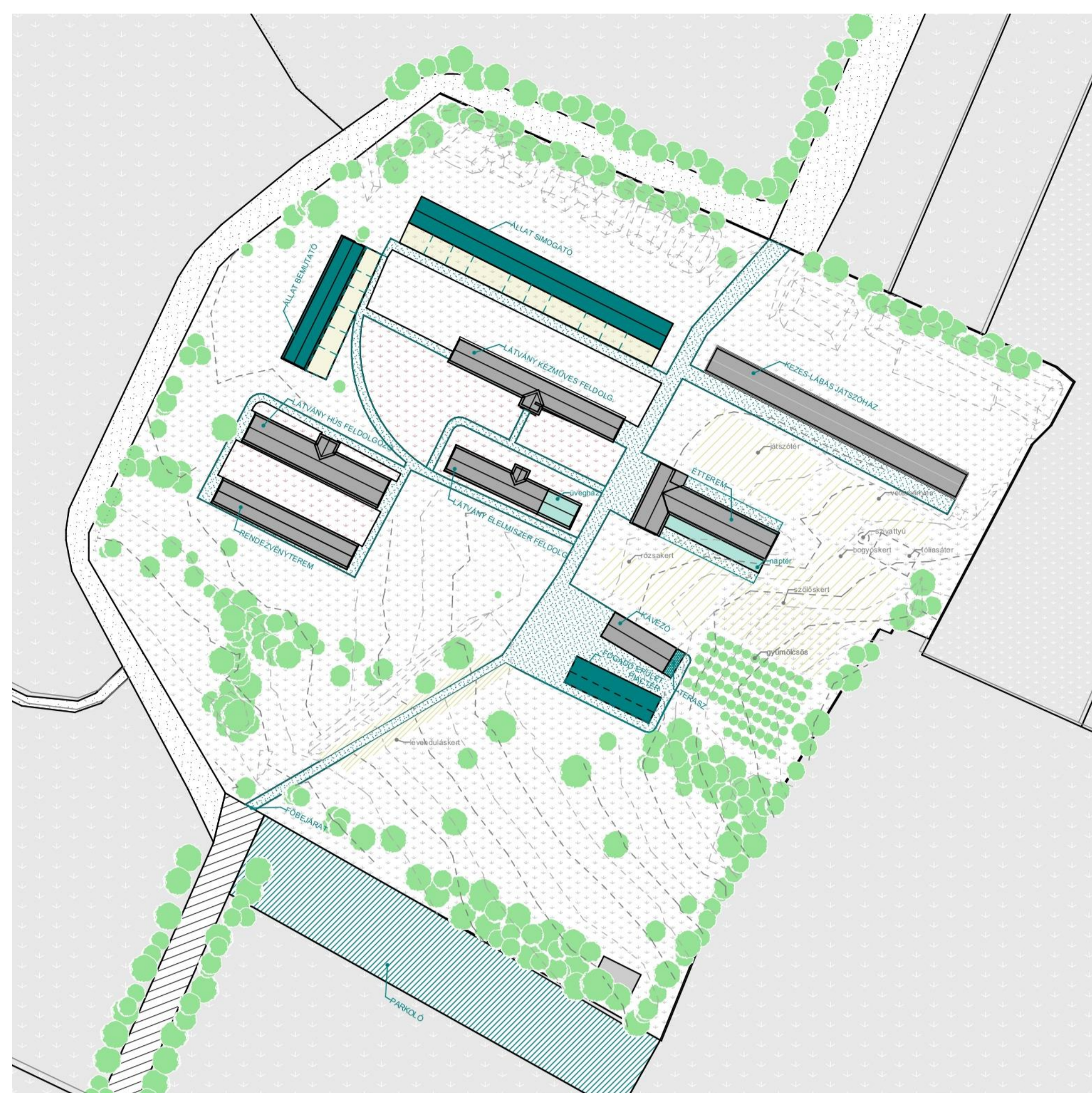

BEÉPÍTÉS – TÖMEGFORMÁLÁS

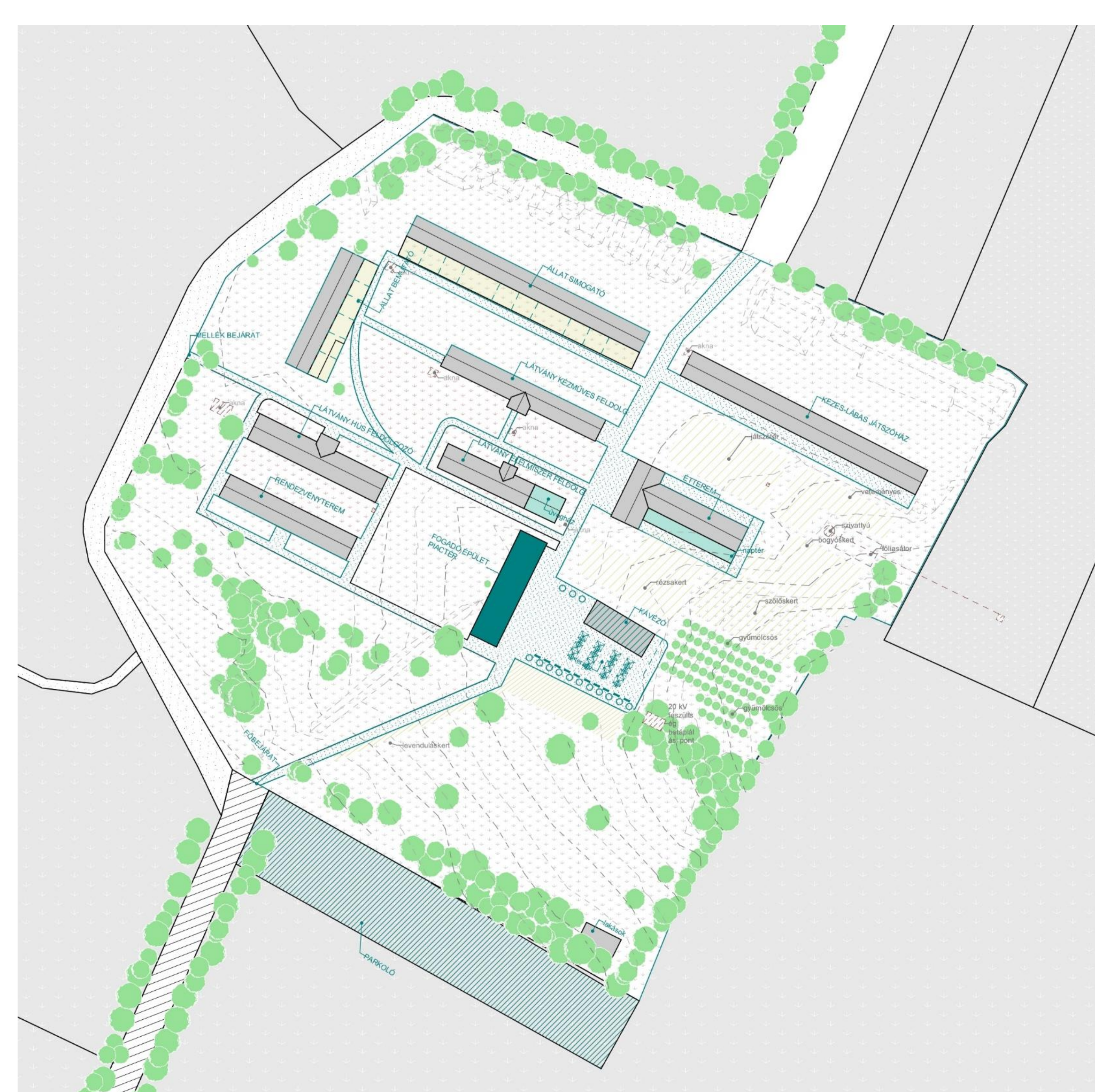
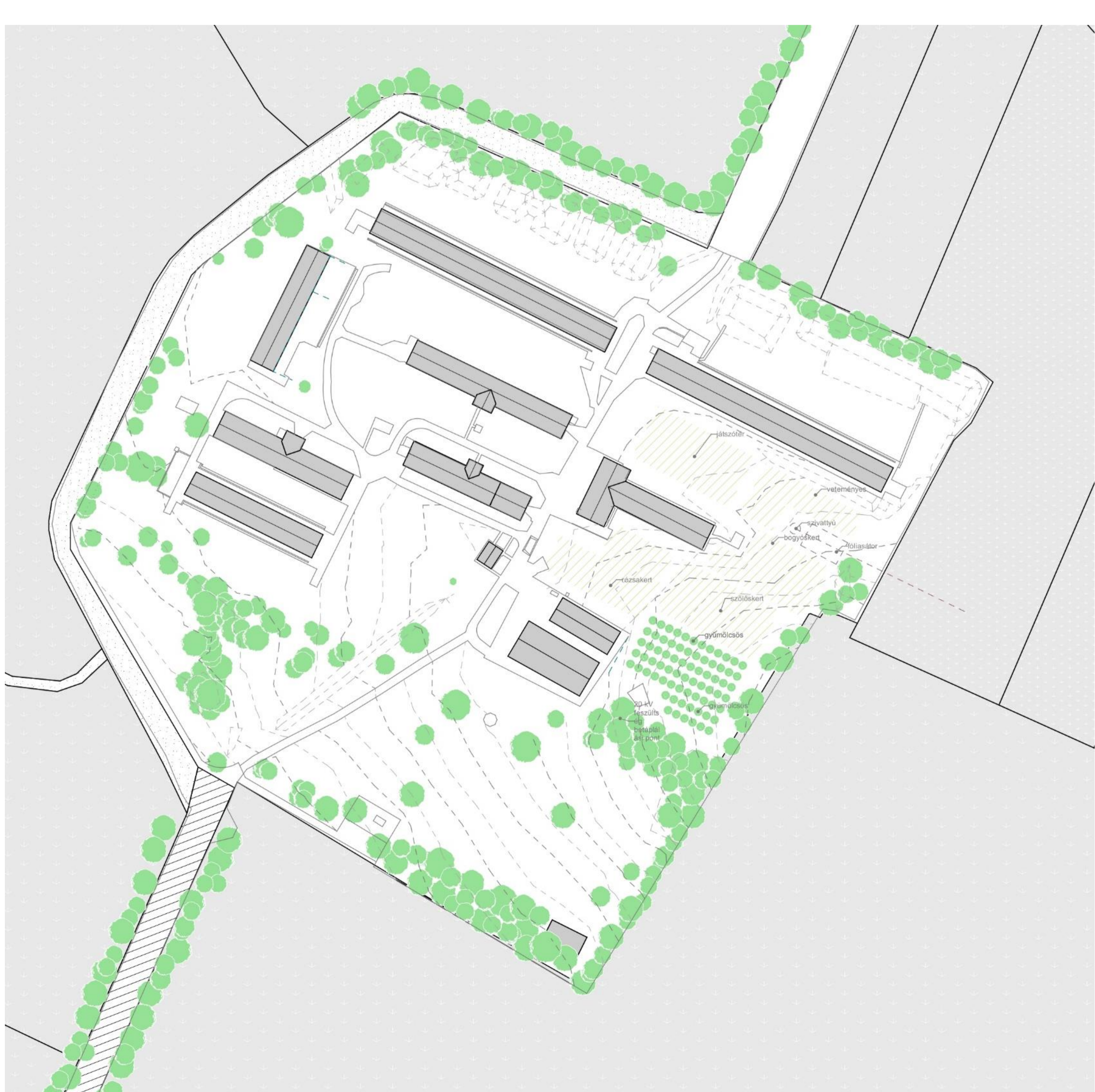
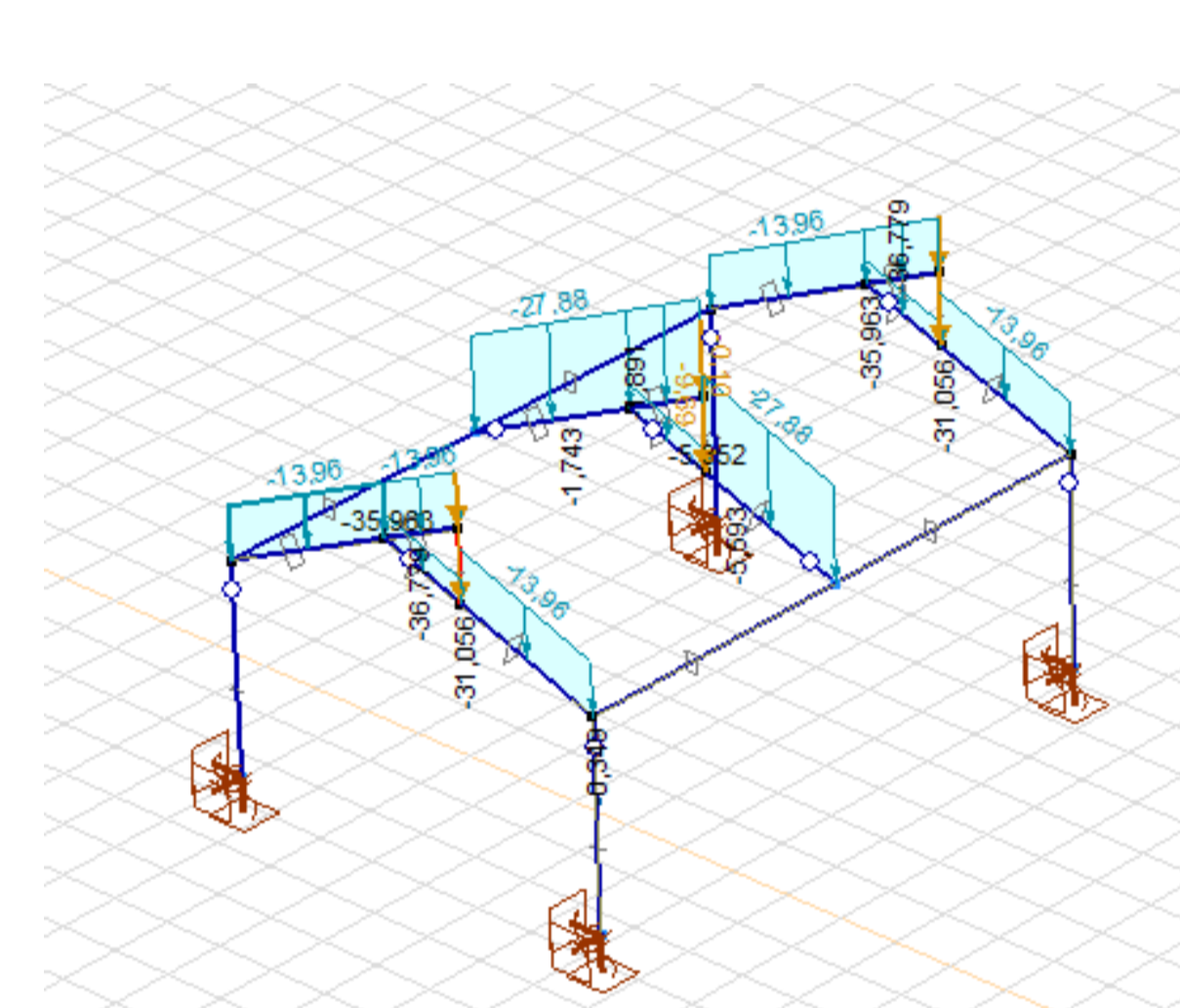
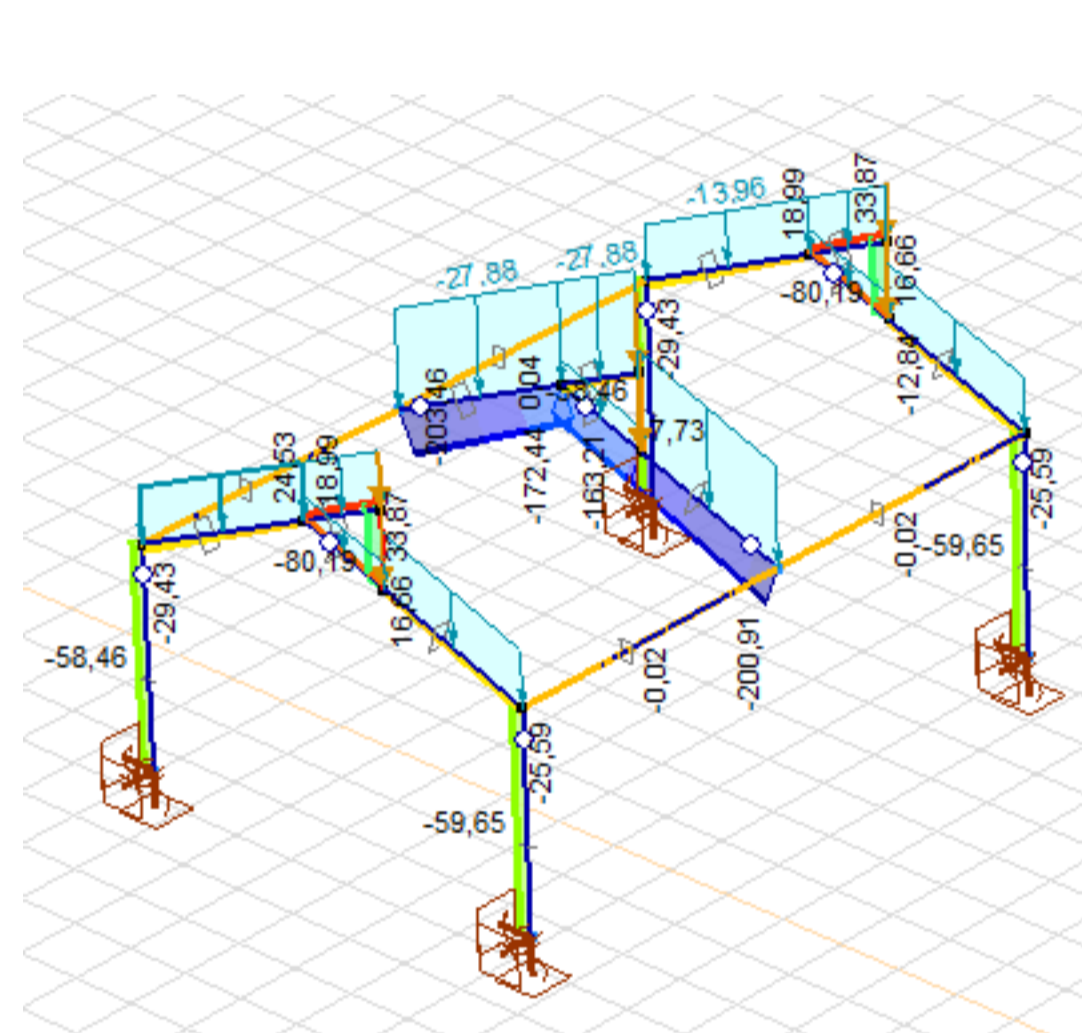
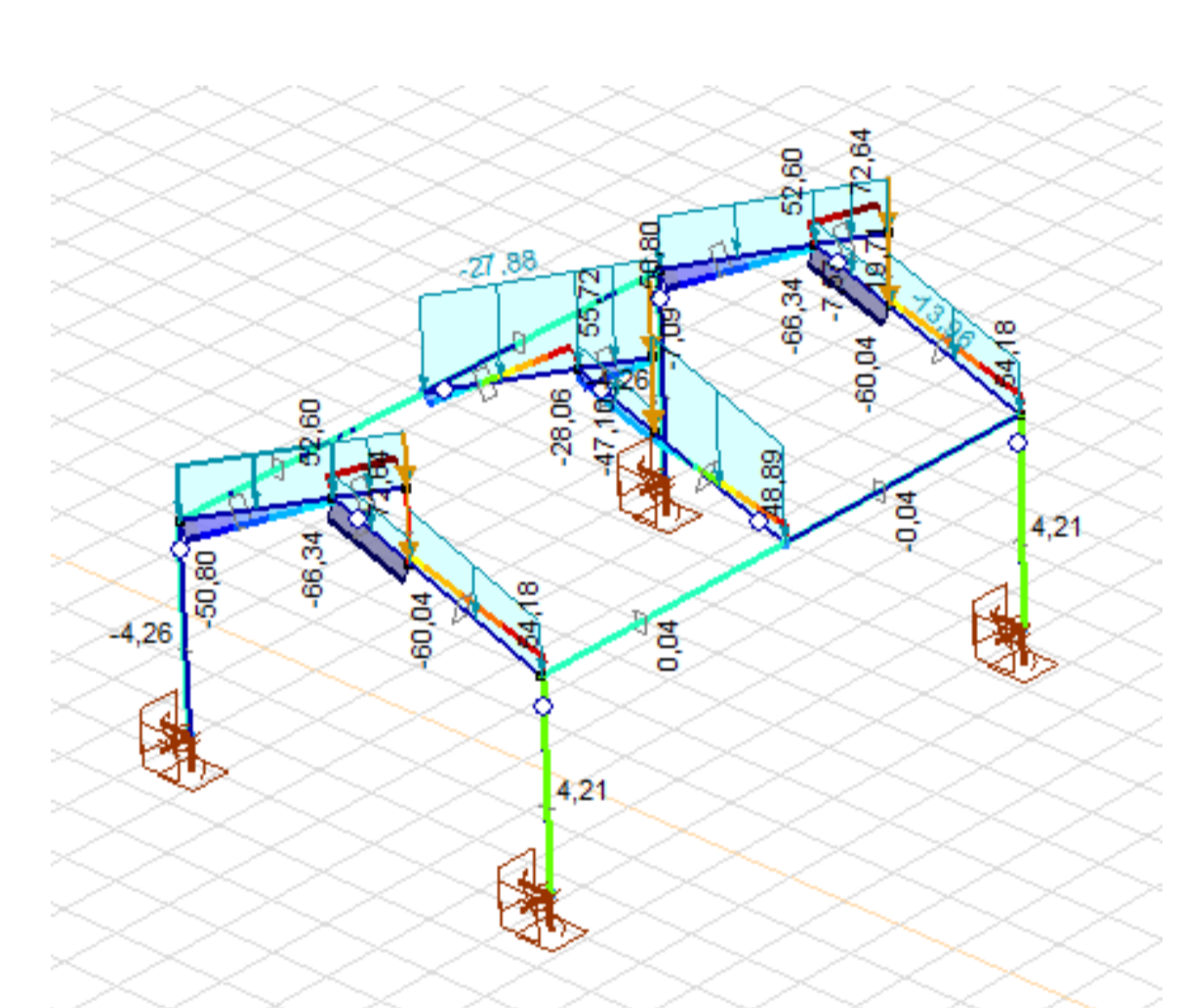
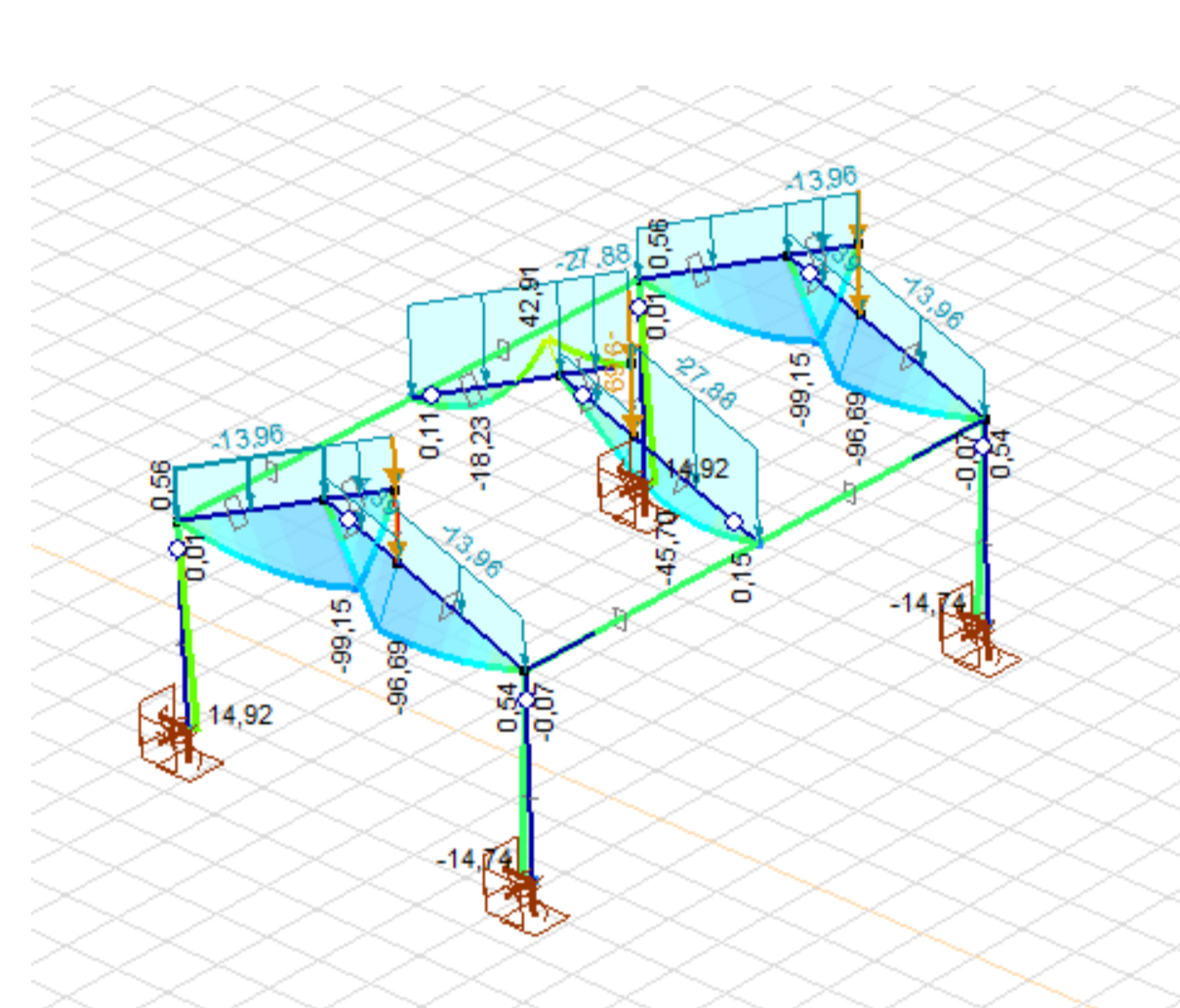
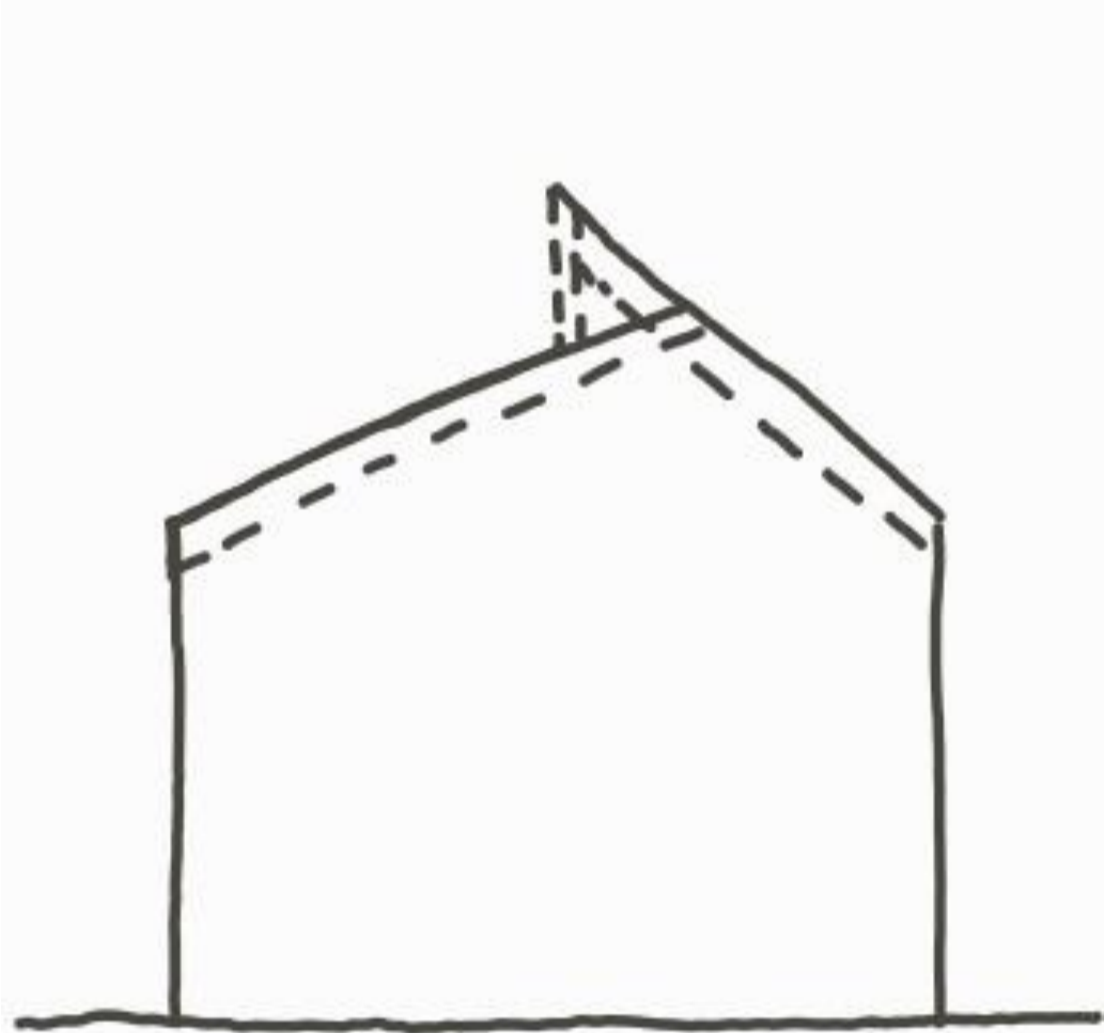
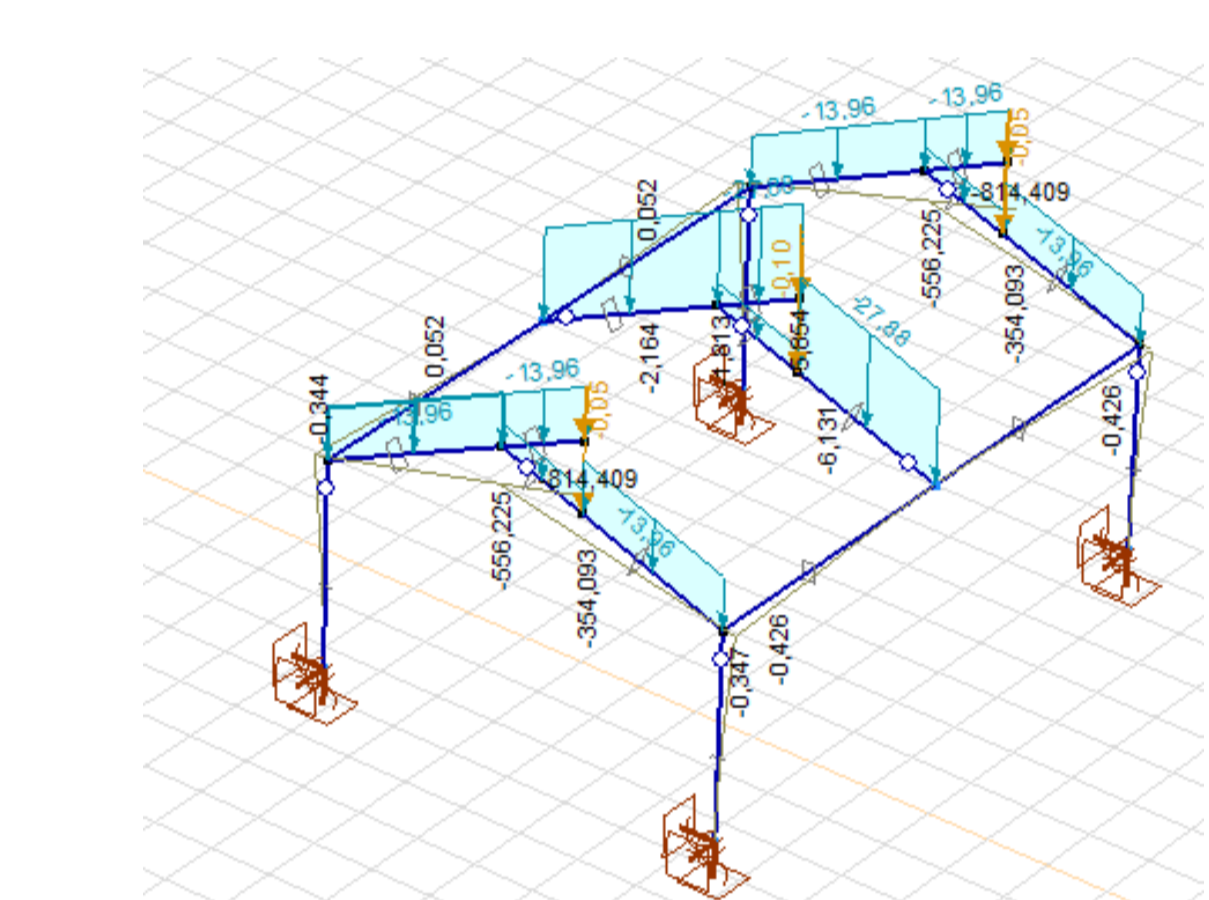
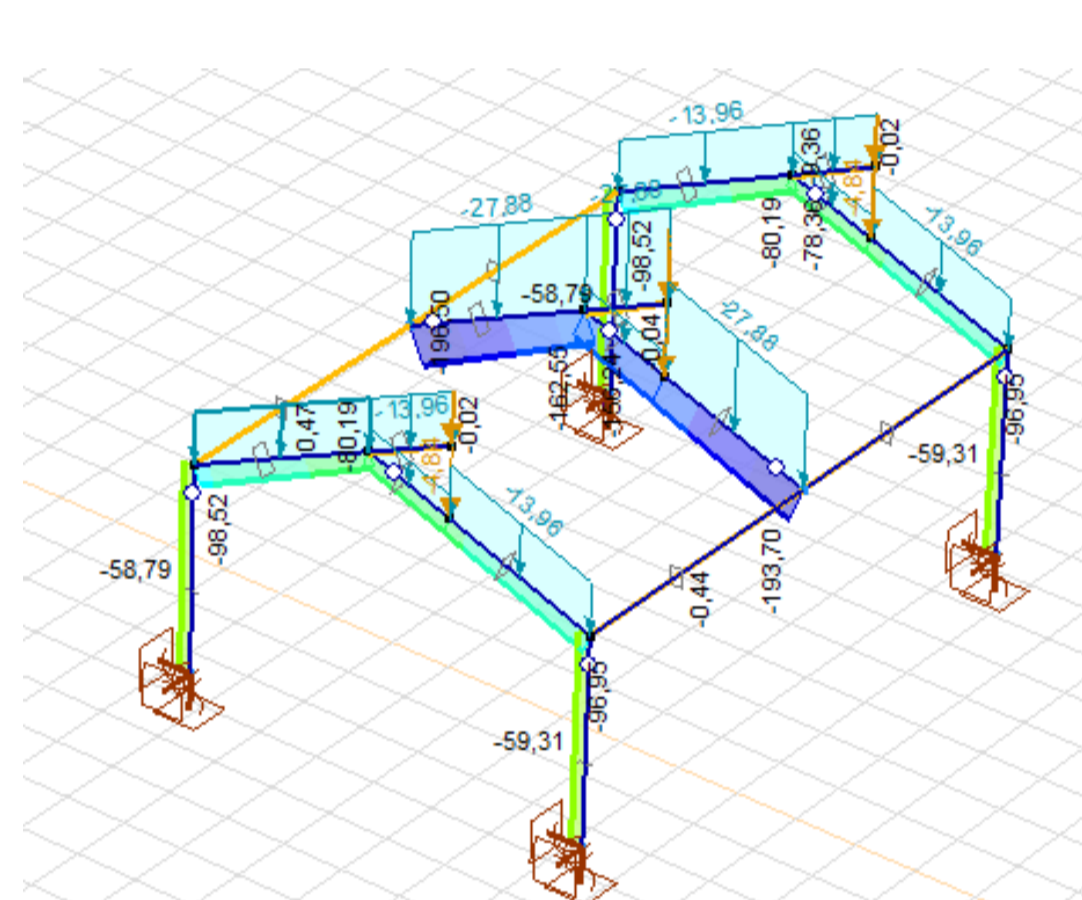
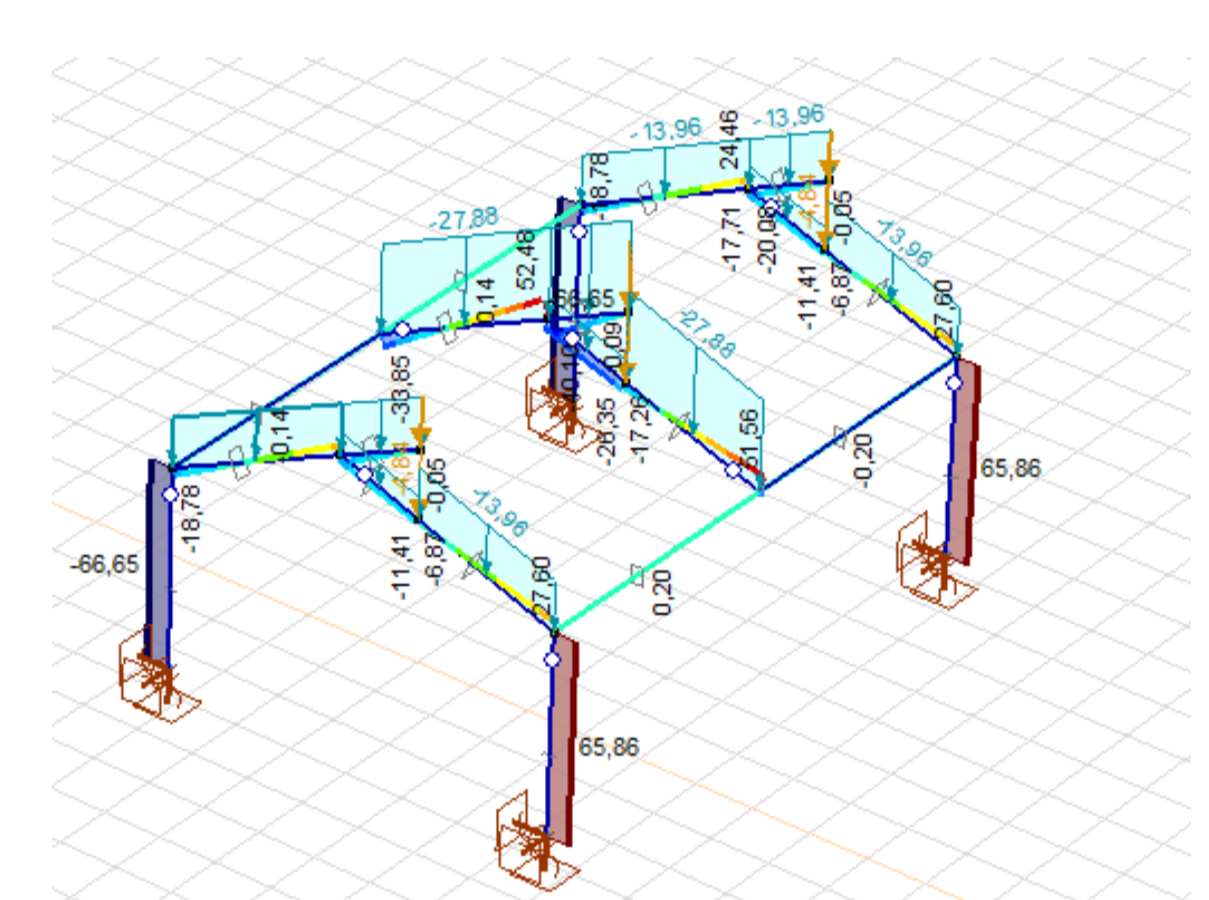
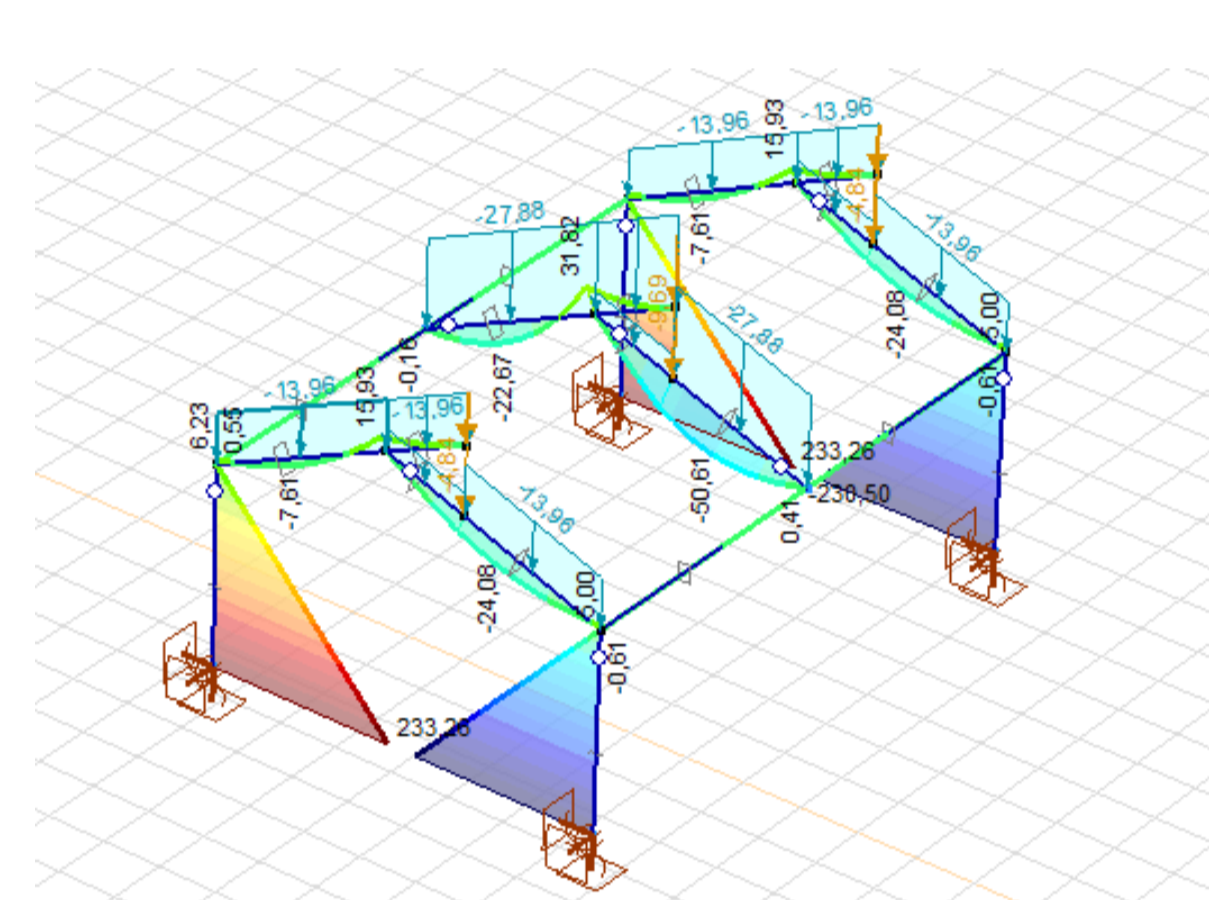
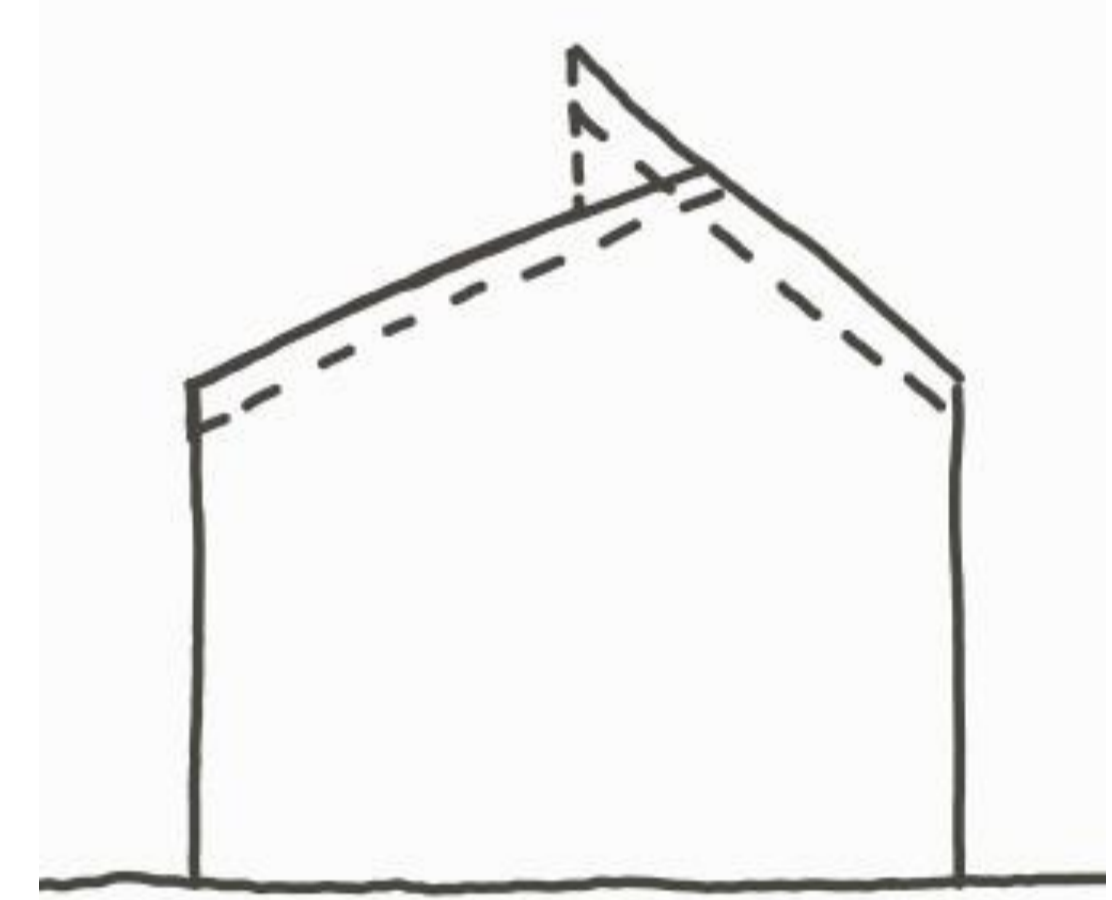
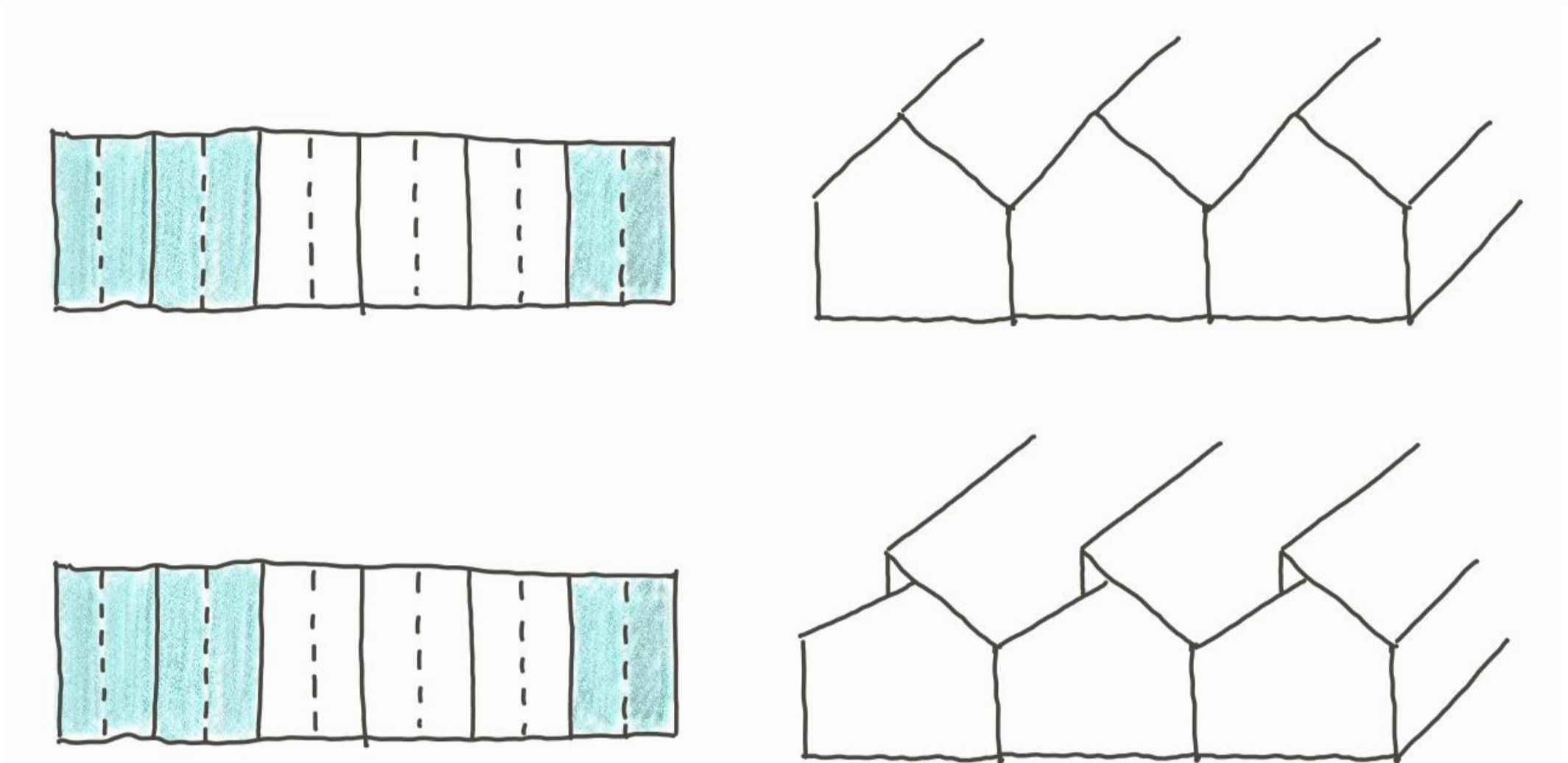
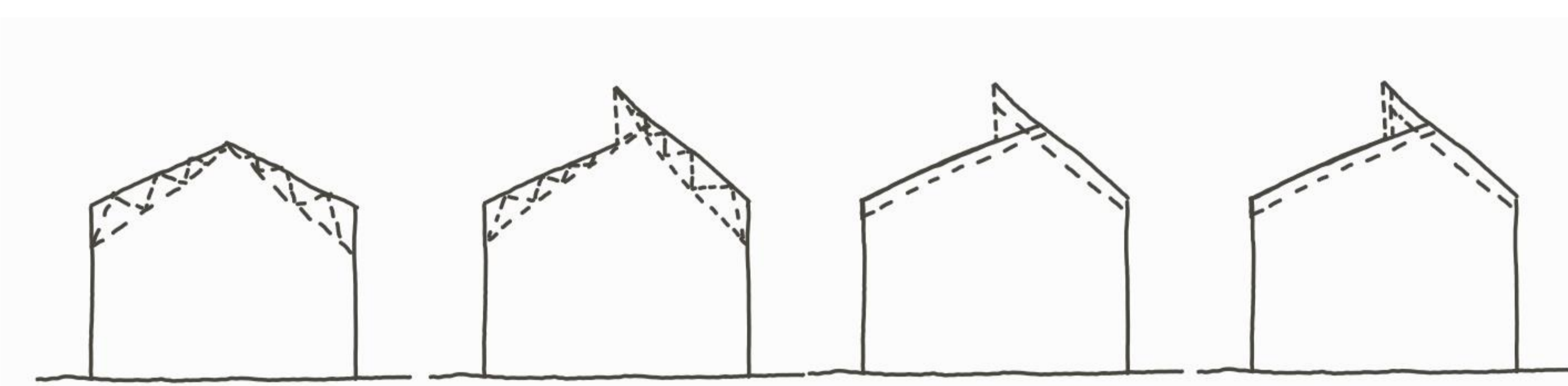
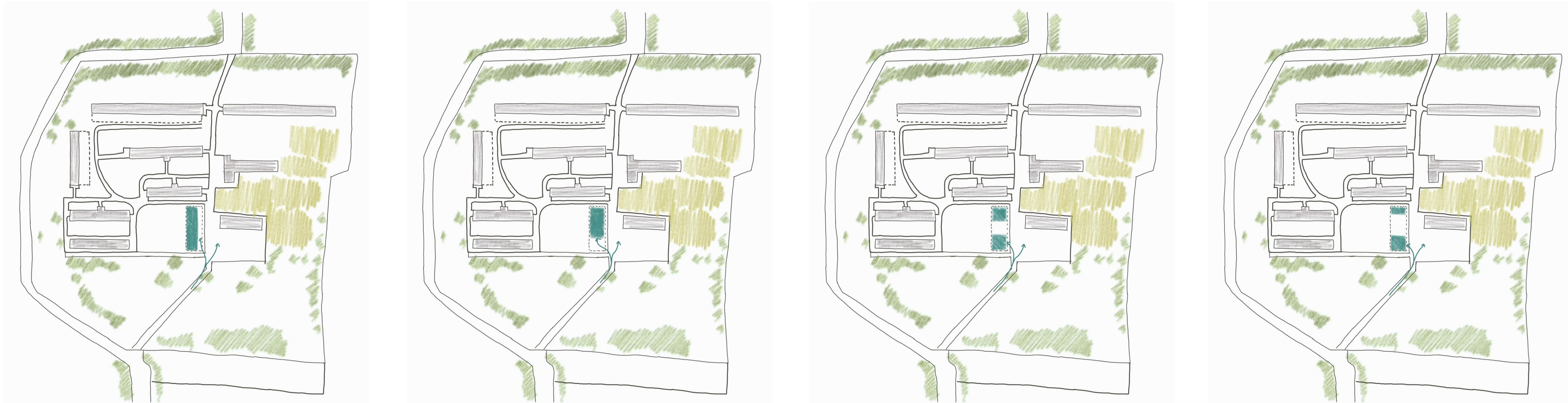

FOGADÓÉPÜLET ÉS MAGTÁR REKONSTRUKCIÓ

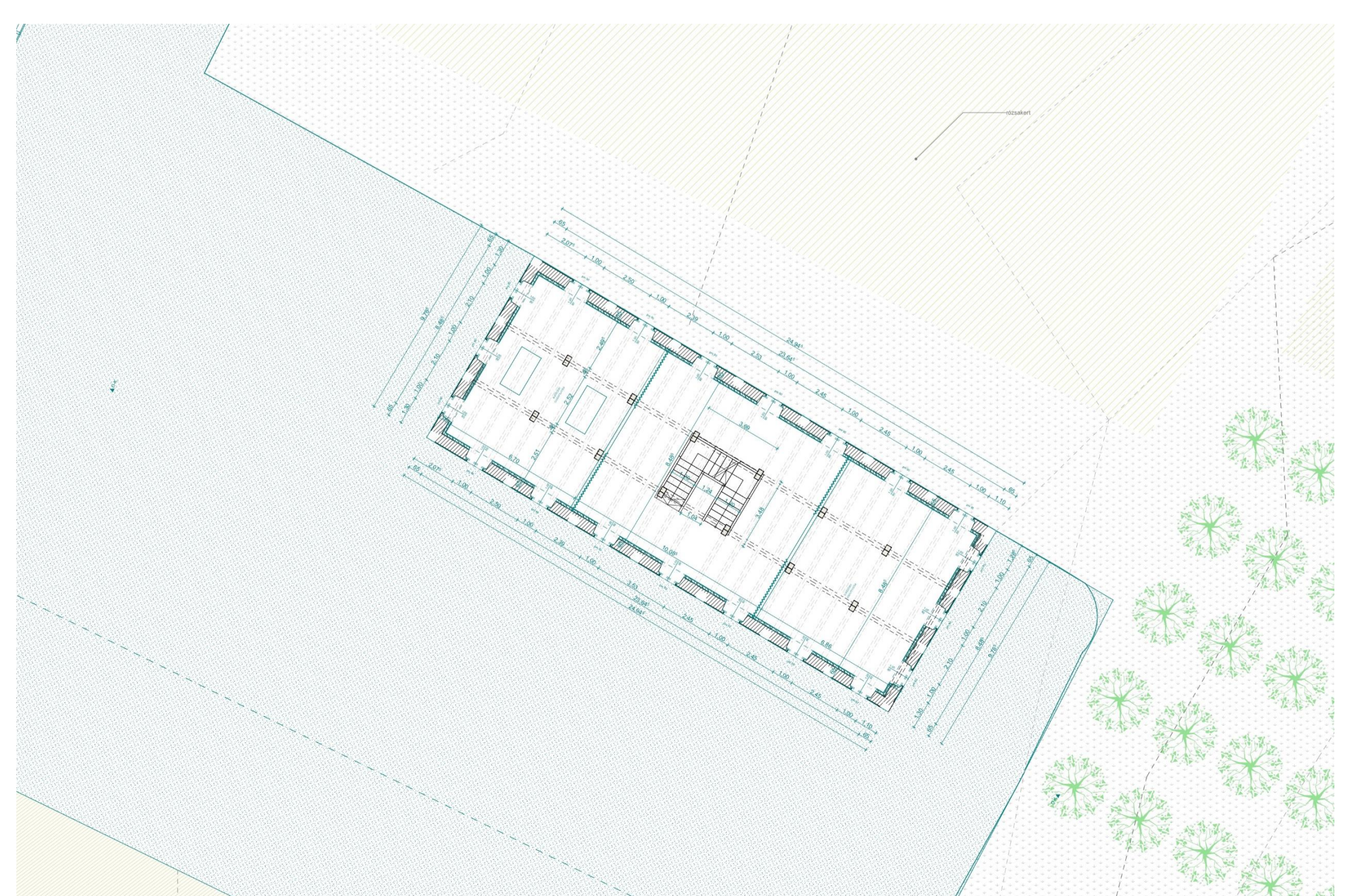

FOGADÓÉPÜLET ÉS MAGTÁR REKONSTRUKCIÓ

D-K HOMLOKZAT M=1:100

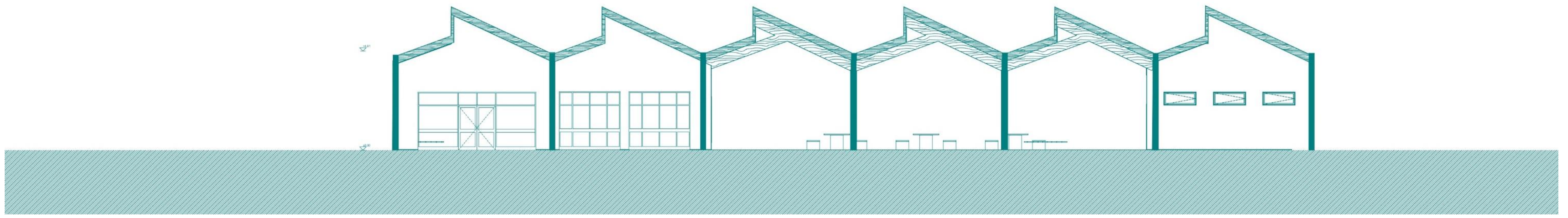

D-NY HOMLOKZAT M=1:100

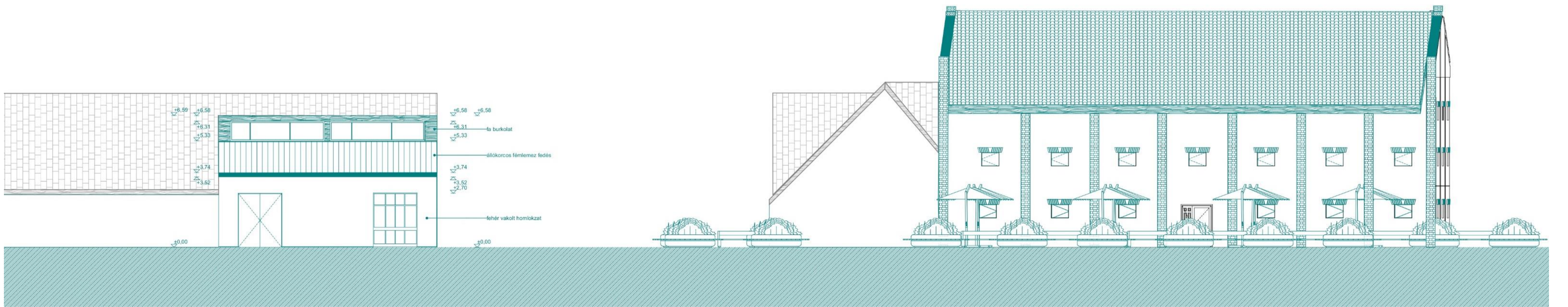

É-K HOMLOKZAT M=1:100

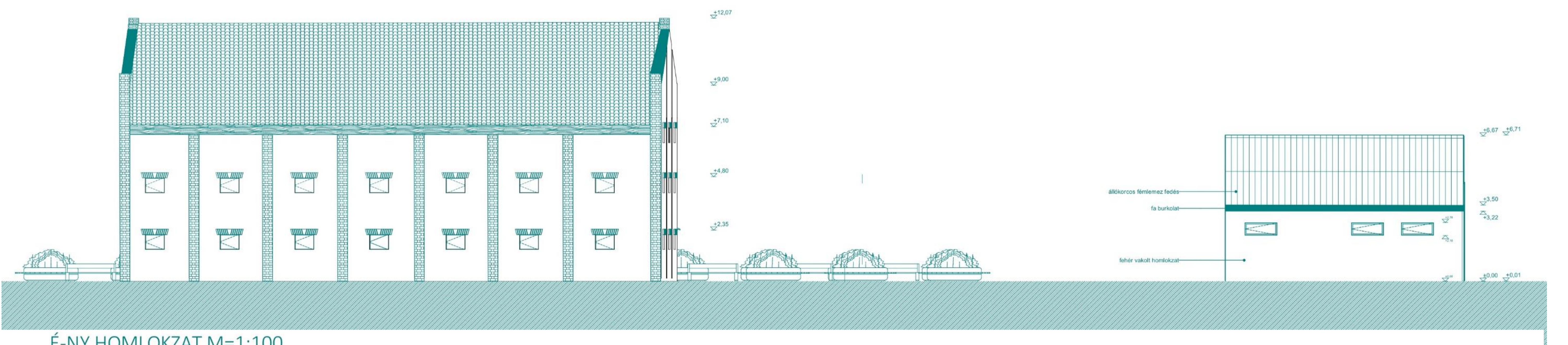

É-NY HOMLOKZAT M=1:100



FOGADÓÉPÜLET ÉS MAGTÁR REKONSTRUKCIÓ

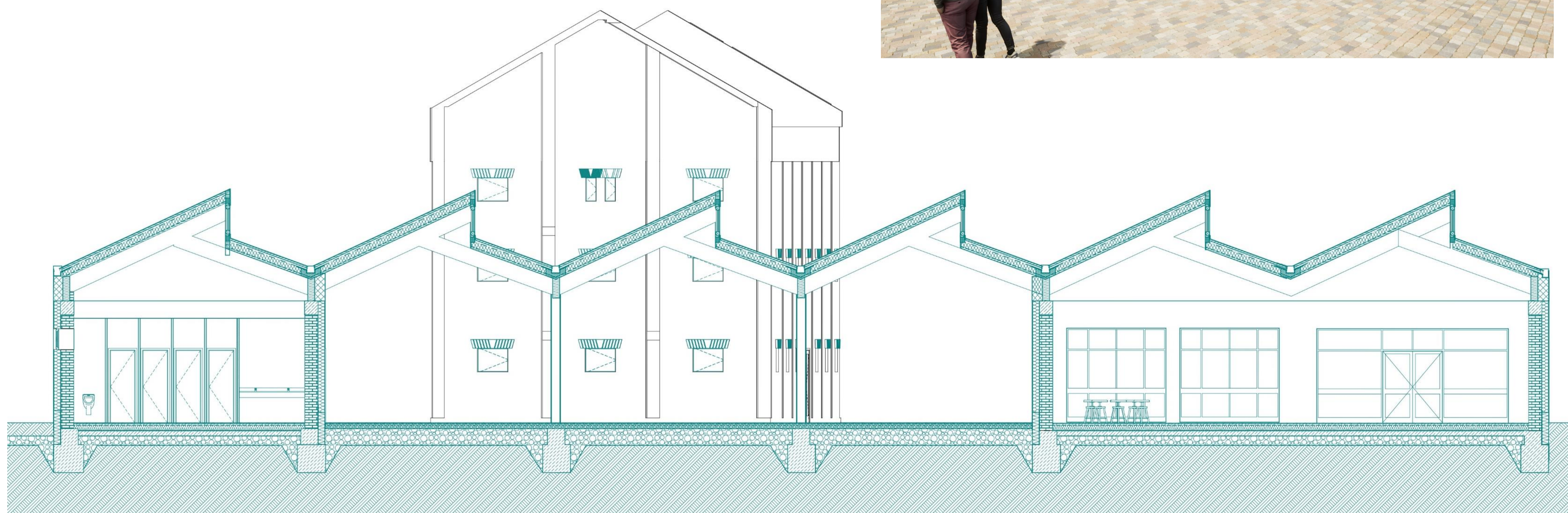
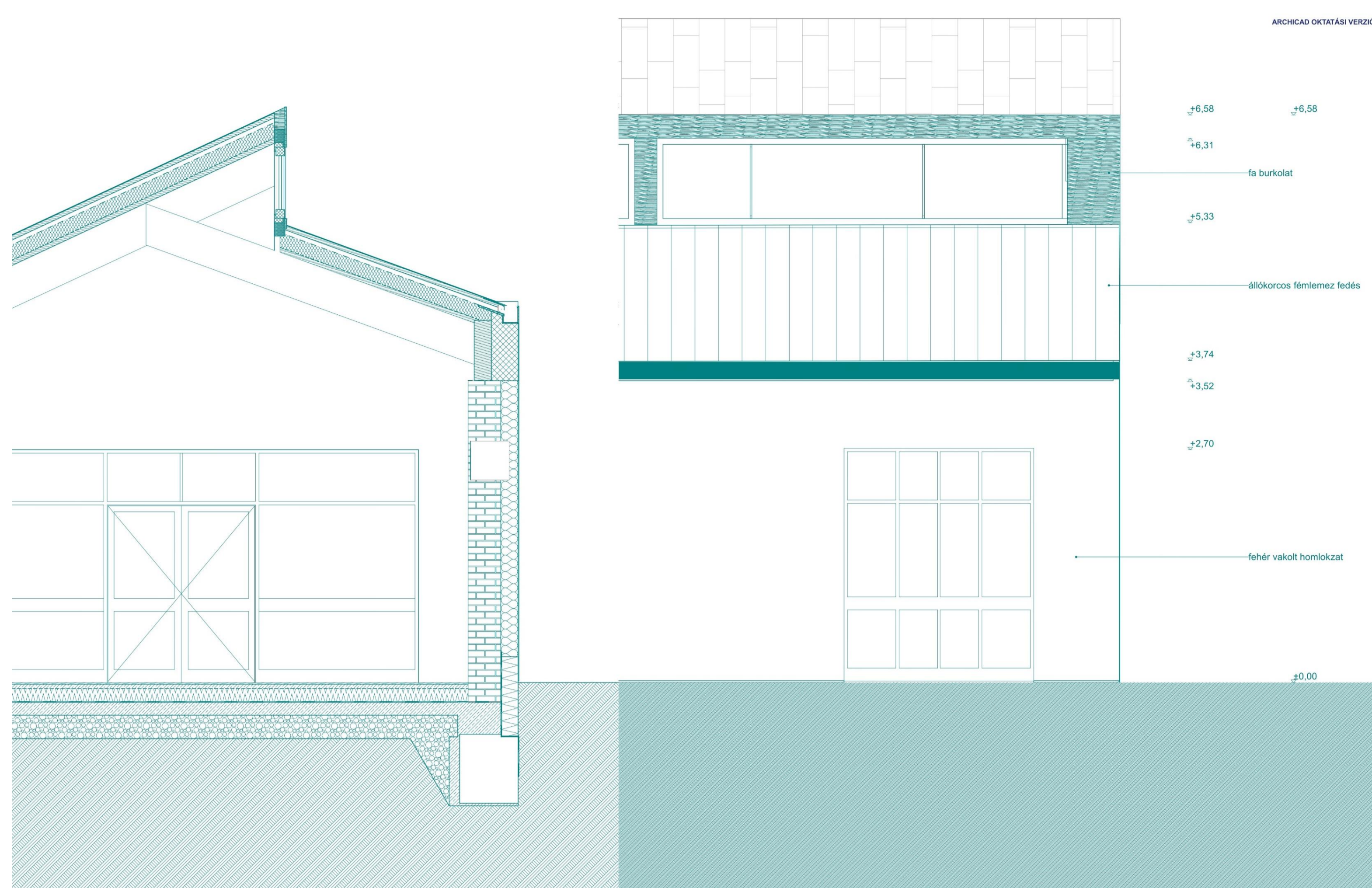

FOGADÓÉPÜLET ÉS MAGTÁR REKONSTRUKCIÓ

